

TECHNICAL CARD



LED Track Light



Pursuant to the provisions of the WEEE Act, it is forbidden to put waste equipment marked with the symbol of a crossed out bin together with other waste. The user, wishing to get rid of electronic and electrical equipment, is obliged to return it to a waste equipment collection point. There are no hazardous components in the equipment that have a particularly negative impact on the environment and human health.

VIDEX®



36°



Ra ≥ 90



ON/OFF

20 000



30 000 h



Free



Not Dimmable



-20° +40°C



No Flicker



No Flicker



CCT 4000K



Free



IP20

WARRANTY 3 YEARS

NEUTRAL WHITE



4000K

Neutral White / Neutralny biały / Neutralni bila / Blanc neuter / Neutrálna biela / Neutraal wit / Semleges feher / Nevtralno bela / Neutralno bijela / Neutralweiß / Alb neutru / Neutralus balta / Neitrāls balta / Neutraalne valge / Нейтрално бяла / Bianco neutro.

General parameters

Light source or containing product Light source

Light source replaceable by the producer

Type of light source

Energy class of the light source F

Dimmable no

Directional (DLS) or non-directional (NDLS) light source DLS

Color-tunable light source no

Mains (MLS) or non-mains (NMLS) light source MLS

Technology LED

VIDEX-TOR-10W-WHITE

INDEX: VLE-TR04-104W

Electrical parameters

On-mode power (Pon) 10 W

Rated voltage, frequency AC 220-240 V, 50/60 Hz

Rated current 87 mA

Input interface 2 Wires Busbar

Electric shock protection class II

Displacement factor (cos φ1) 0.5

Energy consumption in on-mode of the light source (kWh/1000h) 10

Photometric parameters

Useful luminous flux (Φuse) 800 Lm

Correlated color temperature 4000K (neutral white)

Beam angle 36°

Color rendering index (CRI) Ra > 90

On/Off cycles 20000

Lifetime (L70B50) 30000 h

Useful luminous flux of the light source reference in a narrow cone (90°)

Chromaticity coordinates (x) 0.38

Chromaticity coordinates (y) 0.38

R9 colour rendering index value >0

Flicker metric (Pst LM) ≤1

Stroboscopic effect metric (SVM) ≤0.4

Colour consistency in MacAdam ellipses (SDCM) <6 (4000K)

CRI Min Ra 90

CRI Max Ra 95

Additional information

Place of installation	Busbar track
Place of application	indoor
Housing colour	White
Diffuser material	PMMA
Minimum distance from the illuminated object	0.5 m
Ultraviolet radiation	no
Operating temperature range	-20° +40°C
Suitable for installation in normally flammable surfaces	yes
Mercury content	Does not contain
Ingress protection	IP20
Housing material	Aluminum alloy

Dimensions

EAN	5904405541449
In the package	1 pc.
Height	130 mm
Outer box	20 pcs.
Width	50 mm
Depth	50 mm

Signs marking goods

Packaging marking	Recycling of waste, CE, Utilization
-------------------	-------------------------------------







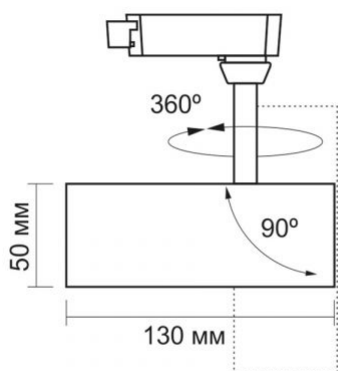













VIDEX®**VIDEX-TOR-10W-WHITE****INDEX: VLE-TR04-104W**

INDEX: VLE-TR04-104W



We reserve the right to make technical changes. The data contained in this material is not legally binding.

Allegro opt Sp. z o.o., ul. Mierzeja Wiślana 11,
30-732 Krakow, Poland.

-  The product must be used indoors
-  Class of protection against electric shock II - provided not only by basic insulation but also by double or reinforced insulation
-  Minimum distance from the illuminated object
0,5 m
-  The product can be installed and used in/on normally flammable surfaces
-  Waste recycling after the end of the product's service life
-  The product meets the requirements of EU directives
-  It is forbidden to throw away waste equipment marked with the symbol of a crossed-out bin with other waste
-  — Rated beam angle
36°
-  — Ra > 90 - color rendering index
Ra > 90
-  — Rated On/off cycles
ON/OFF 20 000
-  — Nominal lifetime (hours)
30 000 h
-  — The product does not emit ultraviolet light
Free
-  — The product is incompatible with light regulators
Not Dimmable
-  — Operating temperatures range
-20°-40°C
-  — The flickering of the light does not exceed the permissible level
No Flicker
-  — The product has minimal flickering, which should not cause discomfort or danger
No Flicker
-  — Colour consistency in MacAdam ellipses (SDCM)
CCT 4000K
-  — The product does not contain mercury
Free
-  — Class of protection against dust and moisture. Protection against solid objects larger than 12 mm; no protection against moisture
IP20