

## TECHNICAL CARD



LED Street Light



Pursuant to the provisions of the WEEE Act, it is forbidden to put waste equipment marked with the symbol of a crossed out bin together with other waste. The user, wishing to get rid of electronic and electrical equipment, is obliged to return it to a waste equipment collection point. There are no hazardous components in the equipment that have a particularly negative impact on the environment and human health.

# VIDEX®

## VIDEX IP65 SLE17 30W 3300Lm 5000K 230V

### INDEX: VL-SLE17-0305



## WARRANTY 2 YEARS

### NEUTRAL WHITE



Neutral White / Neutralny biały / Neutralni bila / Blanc neuter / Neutrálna biela / Neutraal wit / Semleges feher / Nevtralno bela / Neutralno bijela / Neutralweiß / Alb neutru / Neutralus balta / Neitrāls balta / Neutraalne valge / Нейтрално бяла / Bianco neutro.

## General parameters

Light source or containing product	Light source
Light source replaceable	no
Control gear replaceable	-

## Type of light source

Energy class of the light source	E
Dimmable	no
Directional (DLS) or non-directional (NDLS) light source	DLS
Connected light source (cls)	no
Color-tunable light source	no
High luminance light source	No

Mains (MLS) or non-mains (NMLS) light source	MLS
Anti-glare shield	No
Technology	LED

## Electrical parameters

On-mode power (Pon)	30 W
Rated voltage, frequency	AC 180-265 V, 50/60 Hz
Rated current	140 mA
Input interface	Free wire ends
Electric shock protection class	I
Displacement factor (cos φ1)	0.95
Survival factor	0.9
Energy consumption in on-mode of the light source (kWh/1000h)	30

## Photometric parameters

Luminous flux	3300 Lm
Useful luminous flux (Φuse)	3000 Lm
Correlated color temperature	5000K (neutral white)
Beam angle	90 × 130°
Color rendering index (CRI)	Ra > 80
On/Off cycles	20000
Lifetime (L70B50)	30000 h
Useful luminous flux of the light source reference	in a wide cone (120°)
Chromaticity coordinates (x)	0.35

**INDEX: VL-SLE17-0305**

<b>Chromaticity coordinates (y)</b>	0.36
<b>R9 colour rendering index value</b>	>0
<b>The lumen maintenance factor</b>	≥96%
<b>Flicker metric (Pst LM)</b>	≤1
<b>Stroboscopic effect metric (SVM)</b>	outdoor use
<b>Colour consistency in MacAdam ellipses (SDCM)</b>	<6 (5000K)
<b>CRI Min</b>	Ra 80
<b>CRI Max</b>	Ra 88

**Additional information**

<b>Vertical adjustment range</b>	30°
<b>Place of installation</b>	Pillar, Wall
<b>Place of application</b>	indoor, outdoor
<b>Impact protection</b>	IK07
<b>Housing colour</b>	Gray
<b>Diffuser material</b>	Polycarbonate (PC)
<b>Minimum distance from the illuminated object</b>	0.5 m
<b>Ultraviolet radiation</b>	no
<b>Operating temperature range</b>	-30° +50°C
<b>Suitable for installation in normally flammable surfaces</b>	yes
<b>Mercury content</b>	Does not contain
<b>Ingress protection</b>	IP65
<b>Housing material</b>	Aluminum alloy

**Dimensions**

<b>EAN</b>	4820246485579
<b>In the package</b>	1 pc.
<b>Outer box</b>	10 pcs.
<b>Height</b>	409 mm
<b>Width</b>	106 mm
<b>Depth</b>	83 mm
<b>Unit nett weight</b>	630g

**Signs marking goods**
**Packaging marking**

Recycling of  
waste, CE,  
Utilization



**VIDEX<sup>®</sup>**

VIDEX IP65 SLE17 30W 3300Lm 5000K 230V



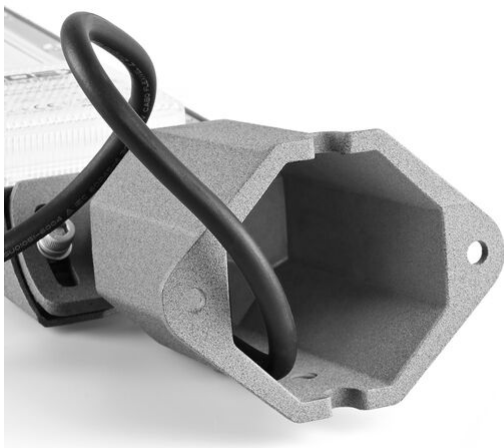
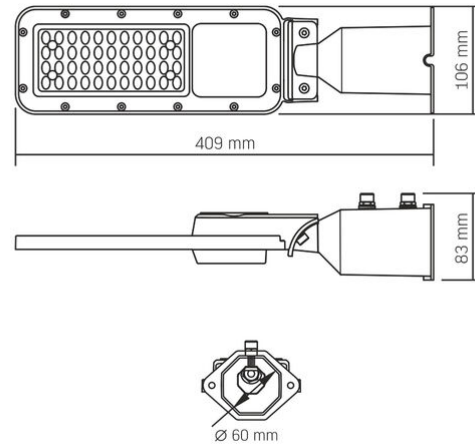
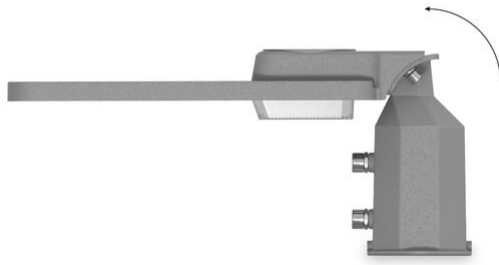

















**INDEX: VL-SLE17-0305**

**VIDEX®****VIDEX IP65 SLE17 30W 3300Lm 5000K 230V****INDEX: VL-SLE17-0305**

We reserve the right to make technical changes. The data contained in this material is not legally binding.

Allegro opt Sp. z o.o., ul. Mierzeja Wiślana 11,  
30-732 Krakow, Poland.

## INDEX: VL-SLE17-0305

-  The product must be used indoors
-  The product must be used outdoors
-  Protection against electric shock class I. A product in which the means of protection against electric shock, in addition to the main insulation, is an additional protective circuit connected to the grounding of the power supply network
-  Minimum distance from the illuminated object  
0,5 m
-  The product can be installed and used in/on normally flammable surfaces
-  Waste recycling after the end of the product's service life
-  The product meets the requirements of EU directives
-  It is forbidden to throw away waste equipment marked with the symbol of a crossed-out bin with other waste
-  — Effective light beam angle  
90°-130°
-  — Ra > 80 - color rendering index  
Ra ≥ 80
-  — Rated On/off cycles  
ON/OFF  
20 000
-  — The product withstands a medium impact (e.g., from a blunt object)  
IK07
-  — Nominal lifetime (hours)  
30 000 h
-  — The product does not emit ultraviolet light  
Free
-  — The product is incompatible with light regulators  
Not Dimmable
-  — Operating temperatures range  
-30° +50°C
-  — The flickering of the light does not exceed the permissible level  
No Flicker
-  — Colour consistency in MacAdam ellipses (SDCM)  
CCT 5000K
-  — The product does not contain mercury  
Free
-  — Class of protection against dust and moisture. The product has full protection against dust and water jets from all directions  
IP65