

## KARTA TECHNICZNA



Oświetlenie szynowe



Zgodnie z przepisami Ustawy o WEEE zabronione jest umieszczanie łącznie z innymi odpadami zużytego sprzętu oznakowanego symbolem przekreślonego kosza. Użytkownik, chcąc pozbyć się sprzętu elektronicznego i elektrycznego, jest zobowiązany do oddania go do punktu zbierania zużytego sprzętu. W sprzęcie nie znajdują się składniki niebezpieczne, które mają szczególnie negatywny wpływ na środowisko i zdrowie ludzi.

# VIDEX®

## VIDEX-TOR-30W-BLACK

### INDEKS: VLE-TR04-304B

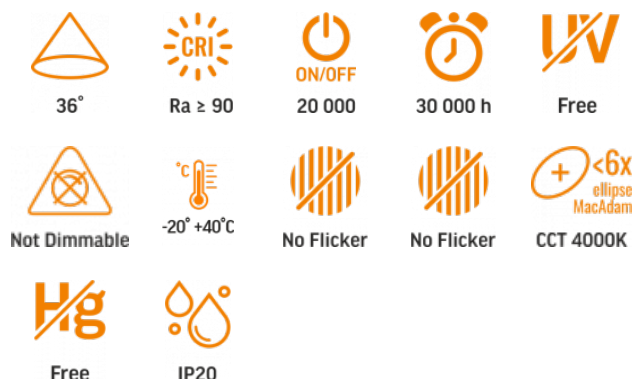

## GWARANCJA 3 LATA

### NEUTRAL WHITE

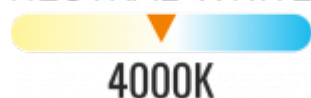

### 4000K

Neutral White / Neutralny biały / Neutralni bila / Blanc neuter / Neutrálna biela / Neutraal wit / Semleges feher / Nevtralno bela / Neutralno bijela / Neutralweiß / Alb neutru / Neutralus balta / Neitrāls balta / Neutraalne valge / Нейтрално бяла / Bianco neutro.

## Parametry ogólne

**Źródło światła lub produkt zawierający źródło światła** Źródło światła

**Wymienne źródło światła** przez producenta

## Rodzaj źródła światła

**Klasa energetyczna** F

**Możliwość przyciemniania** nie

**Kierunkowe (DLS) lub bezkierunkowe (NDLS) źródło światła** DLS

**Regulowane kolorystycznie źródło światła** nie

**Źródło światła zasilane z sieci (MLS) lub niezasilane z sieci (NMLS)** MLS

**Technologia** LED

## Parametry elektryczne

<b>Moc w trybie włączenia (Pon)</b>	30 W
<b>Napięcie znamionowe, częstotliwość</b>	AC 220-240 V, 50/60 Hz
<b>Maksymalne natężenie prądu</b>	145 mA
<b>Interfejs wejściowy</b>	2 Wires Busbar
<b>Klasa ochronności przed porażeniem elektrycznym</b>	II
<b>Współczynnik przesunięcia fazowego (cos φ1)</b>	0.9
<b>Zużycie energii w trybie pracy źródła światła (kWh/1000h)</b>	30

## Parametry fotometryczne

<b>Useful luminous flux (Φuse)</b>	2400 Lm
<b>Temperatura barwowa światła</b>	4000K (neutralny biały)
<b>Kąt rozproszenia</b>	36°
<b>Wskaźnik oddawania barw</b>	Ra > 90
<b>Cykle włącz/wyłącz</b>	20000
<b>Godziny pracy (L70B50)</b>	30000 godz
<b>Użyteczny strumień świetlny źródła światła Φuse [lm]</b>	w wąskim stożku (90°)
<b>Współrzędne chromatyczności (x)</b>	0.38
<b>Współrzędne chromatyczności (y)</b>	0.38
<b>Wartość wskaźnika oddawania barw R9</b>	>0
<b>Współczynnik migotania (Pst LM)</b>	≤1
<b>Współczynnik efektu stroboskopowego (SVM)</b>	≤0.4

**VIDEX®**

VIDEX-TOR-30W-BLACK

INDEKS: VLE-TR04-304B

Spójność barw w elipsach MacAdama (SDCM)	<6 (4000K)
CRI MIN	Ra 90
CRI MAX	Ra 95

### Dodatkowe informacje

Miejsce instalacji	Szyna zbiorcza
Środowisko użytkowania	wewnątrz
Kolor obudowy	Czarny
Materiał dyfuzora	PMMA
Minimalna odległość od oświetlanego obiektu	0.5 m
Promieniowanie ultrafioletowe	nie
Zakres temperatur pracy	-20° +40°C
Odpowiednie do instalacji na normalnie palnych powierzchniach	tak
Zawartość rtęci	nie
Klasa ochrony IP	IP20
Materiał obudowy	Stop Aluminium

### Wymiary

Kod EAN	5904405541470
W paczce	1 szt.
Opakowanie zbiorcze	20 szt.
Wysokość	180 mm
Szerokość	77 mm
Głębokość	77 mm

### Znaki oznaczające towary

#### Oznakowanie opakowań

Przetwarzanie odpadów, CE, Utylizacja



**VIDEX<sup>®</sup>****VIDEX-TOR-30W-BLACK****INDEKS: VLE-TR04-304B**

## INDEKS: VLE-TR04-304B

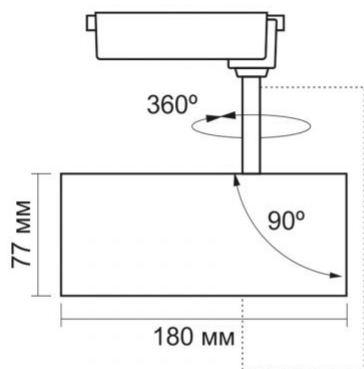

Zastrzegamy sobie prawo do zmian technicznych. Dane zawarte w tym materiał nie jest prawnie wiążący.

Allegro opt Sp. z o.o., ul. Mierzeja Wiślana 11,  
30-732 Krakow, Polska.

-  Produkt musi być używany wewnątrz
-  Klasa ochrony przed porażeniem prądem elektrycznym II - zapewniana nie tylko przez izolację podstawową, ale także przez izolację podwójną lub wzmocnioną
-  Minimalna odległość od oświetlanego obiektu  
0,5 m
-  Produkt może być instalowany i używany w/na powierzchniach normalnie palnych
-  Recykling odpadów po zakończeniu okresu użytkowania produktu
-  Produkt spełnia wymagania dyrektyw UE
-  Zabrania się wyrzucania zużytego sprzętu oznaczonego symbolem przekreślonego kontenera razem z innymi odpadami
-  36° — Znamionowy kąt rozsyłu światła
-  Ra > 90 — Indeks oddawania barw
-  On/Off 20 000 — Znamionowe cykle włączenia/wyłączenia
-  30 000 h — Żywotność nominalna (godzin)
-  Free — Produkt nie emituje promieniowania ultrafioletowego
-  Not Dimmable — Produkt jest niekompatybilny z regulatorami światła
-  -20°-40°C — Zakres temperatur pracy
-  No Flicker — Migotanie światła nie przekracza dopuszczalnego poziomu
-  No Flicker — Produkt ma minimalne migotanie, które nie powinno powodować dyskomfortu ani zagrożenia
-  SDCM CCT 4000K — Spójność barw w elipsach MacAdama (SDCM)
-  Free — Produkt nie zawiera rtęci
-  IP20 — Klasa ochrony przed kurzem i wilgocią. Ochrona przed ciałami stałymi o wymiarach większych niż 12 mm; brak ochrony przed wilgocią