

## TECHNICAL CARD



LED Floodlight



Pursuant to the provisions of the WEEE Act, it is forbidden to put waste equipment marked with the symbol of a crossed out bin together with other waste. The user, wishing to get rid of electronic and electrical equipment, is obliged to return it to a waste equipment collection point. There are no hazardous components in the equipment that have a particularly negative impact on the environment and human health.

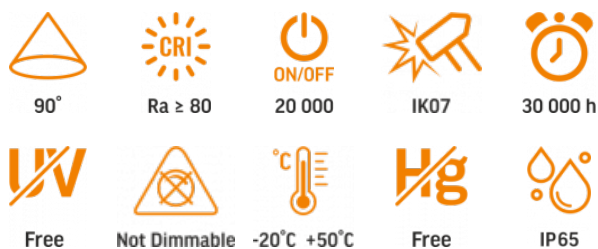

## WARRANTY 2 YEARS

### NEUTRAL WHITE



Neutral White / Neutralny biały / Neutralni bila / Blanc neuter / Neutrálna biela / Neutraal wit / Semleges feher / Nevtralno bela / Neutralno bijela / Neutralweiß / Alb neutru / Neutralus balta / Neitrāls balta / Neutraalne valge / Неутрално бяла / Bianco neutro.

### General parameters

Light source or containing product	Light source
Light source replaceable	no
Control gear replaceable	-

### Type of light source

Energy class of the light source	F
Dimmable	no
Technology	LED

### Electrical parameters

On-mode power (Pon)	50 W
Rated voltage, frequency	AC 220-240 V, 50/60 Hz
Cable length	30 cm
Rated current	240 mA

### INDEX: VLE-F2e-505W-S

Input interface	Free wire ends
Electric shock protection class	I

### Photometric parameters

Useful luminous flux (Φuse)	4500 Lm
Correlated color temperature	5000K (neutral white)
Peak luminous intensity	3200 cd
Beam angle	90°
Color rendering index (CRI)	Ra > 80
On/Off cycles	20000
Lifetime (L70B50)	30000 h
Useful luminous flux of the light source reference	in a wide cone (120°)
Sensor light threshold	10-2000 Lx
CRI Min	Ra 80
CRI Max	Ra 88

### Additional information

Vertical adjustment range	180°
Place of installation	Ceiling, Flat surface, Wall
Place of application	outdoor
Impact protection	IK07
Housing colour	White
Diffuser material	Polycarbonate (PC)
Minimum distance from the illuminated object	0.5 m

### INDEX: VLE-F2e-505W-S

<b>Ultraviolet radiation</b>	no
<b>Motion sensor</b>	yes
<b>Sensor type</b>	PIR
<b>Sensor time delay</b>	10 s - 7 min
<b>Sensor detection angle</b>	120°
<b>Sensor detection distance</b>	2 - 8 m
<b>Operating temperature range</b>	-20° +50°C
<b>Mercury content</b>	Does not contain
<b>Ingress protection</b>	IP65
<b>Housing material</b>	Aluminum alloy

### Dimensions

<b>EAN</b>	5904405541173
<b>In the package</b>	1 pc.
<b>Height</b>	215 mm
<b>Outer box</b>	10 pcs.
<b>Width</b>	223 mm
<b>Depth</b>	54 mm
<b>Unit nett weight</b>	590g

### Signs marking goods

<b>Packaging marking</b>	Recycling of waste, CE, Utilization
--------------------------	-------------------------------------



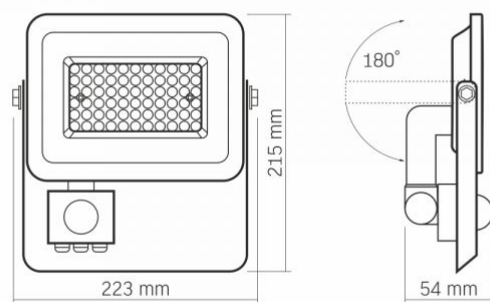



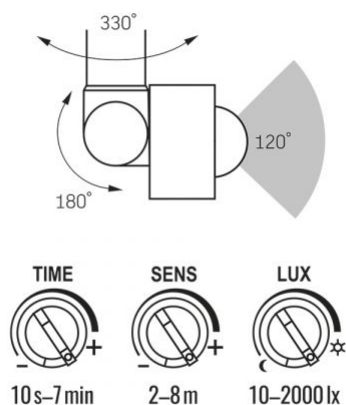











**VIDEX<sup>®</sup>****VIDEX-FLOOD-LED-PIR-LUCA-50W-NW****INDEX: VLE-F2e-505W-S**

### INDEX: VLE-F2e-505W-S



We reserve the right to make technical changes. The data contained in this material is not legally binding.

Allegro opt Sp. z o.o., ul. Mierzeja Wiślana 11,  
30-732 Krakow, Poland.

-  The product must be used outdoors
-  Protection against electric shock class I. A product in which the means of protection against electric shock, in addition to the main insulation, is an additional protective circuit connected to the grounding of the power supply network
-  Minimum distance from the illuminated object  
0,5 m
-  Waste recycling after the end of the product's service life
-  The product meets the requirements of EU directives
-  It is forbidden to throw away waste equipment marked with the symbol of a crossed-out bin with other waste
-  — Rated beam angle  
90°
-  — Ra > 80 - color rendering index  
Ra = 80
-  — Rated On/off cycles  
20 000
-  — The product withstands a medium impact (e.g., from a blunt object)  
IK07
-  — Nominal lifetime (hours)  
30 000 h
-  — The product does not emit ultraviolet light  
Free
-  — The product is incompatible with light regulators  
Not Dimmable
-  — Operating temperatures range  
-20°C +50°C
-  — The product does not contain mercury  
Free
-  — Class of protection against dust and moisture. The product has full protection against dust and water jets from all directions  
IP65