

## TECHNICAL CARD



LED Ceiling Light with decorative backlight



Pursuant to the provisions of the WEEE Act, it is forbidden to put waste equipment marked with the symbol of a crossed out bin together with other waste. The user, wishing to get rid of electronic and electrical equipment, is obliged to return it to a waste equipment collection point. There are no hazardous components in the equipment that have a particularly negative impact on the environment and human health.

### INDEX: VL-DL5R-22CB



### WARRANTY 2 YEARS

#### General parameters

Light source or containing product	Light source
Light source replaceable	no

#### Type of light source

Energy class of the light source	F
Dimmable	no
Directional (DLS) or non-directional (NDLS) light source	NDLS
Connected light source (cls)	no
Color-tunable light source	yes
Mains (MLS) or non-mains (NMLS) light source	MLS
High luminance light source	No
Anti-glare shield	No
Technology	LED

#### Electrical parameters

On-mode power (Pon)	22 W
Rated voltage, frequency	AC 220-240 V, 50/60 Hz
Rated current	136 mA
Input interface	Terminal block
Electric shock protection class	II
Displacement factor (cos φ1)	0.7
Survival factor	1
Energy consumption in on-mode of the light source (kWh/1000h)	22

#### Photometric parameters

Useful luminous flux (Φuse)	2400 Lm
Correlated color temperature	5000K (neutral white), 4000K (neutral white), 3000K (warm white)
Beam angle	140°
Color rendering index (CRI)	Ra > 80
On/Off cycles	20000
Lifetime (L70B50)	30000 h
Useful luminous flux of the light source reference	in a sphere (360°)
R9 colour rendering index value	>0
The lumen maintenance factor	≥96%
Flicker metric (Pst LM)	≤1
Stroboscopic effect metric (SVM)	-

### INDEX: VL-DL5R-22CB

Colour consistency in MacAdam ellipses (SDCM) <6 (3000K), <6 (4000K), <6 (5000K)

CRI Min Ra 80

CRI Max Ra 88

### Additional information

Place of installation Ceiling

Place of application indoor, outdoor

Housing colour Black

Diffuser material Polypropylene (PP)

Minimum distance from the illuminated object 0.5 m

Ultraviolet radiation no

Operating temperature range -20° +40°C

Suitable for installation in normally flammable surfaces yes

Mercury content Does not contain

Ingress protection IP54

Housing material ABS

### Dimensions

EAN 4820246487344

In the package 1 pc.

Outer box 20 pcs.

Height 293 mm

Width 293 mm

Depth 26 mm

Unit nett weight 580g

### Signs marking goods

Packaging marking

Recycling of waste, CE, Utilization



**VIDEX**<sup>®</sup>

VIDEX DL5R 22W 3000K-4000K-5000K 230V Black

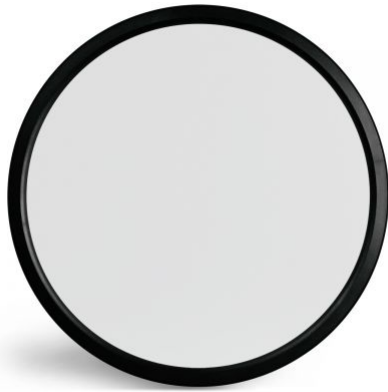
**INDEX: VL-DL5R-22CB**

**VIDEX<sup>®</sup>**



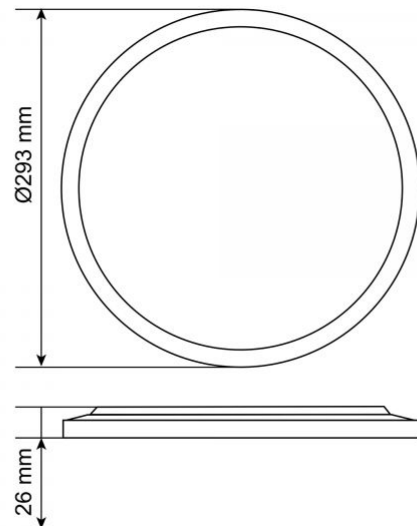











VIDEX DL5R 22W 3000K-4000K-5000K 230V Black

**INDEX: VL-DL5R-22CB**

We reserve the right to make technical changes. The data contained in this material is not legally binding.

Allegro opt Sp. z o.o., ul. Mierzeja Wiślana 11,  
30-732 Krakow, Poland.

## INDEX: VL-DL5R-22CB

-  The product must be used indoors
-  The product must be used outdoors
-  Class of protection against electric shock II - provided not only by basic insulation but also by double or reinforced insulation
-  Minimum distance from the illuminated object  
0,5 m
-  The product can be installed and used in/on normally flammable surfaces
-  Waste recycling after the end of the product's service life
-  The product meets the requirements of EU directives
-  It is forbidden to throw away waste equipment marked with the symbol of a crossed-out bin with other waste
-  — Ra > 80 - color rendering index
-  — Rated On/off cycles  
20 000
-  — Nominal lifetime (hours)  
30 000 h
-  — The product does not emit ultraviolet light  
Free
-  — The product is incompatible with light regulators  
Not Dimmable
-  — Operating temperatures range  
-20° +40°C
-  — The flickering of the light does not exceed the permissible level  
No Flicker
-  — Colour consistency in MacAdam ellipses (SDCM)  
CCT 3000K
-  — Colour consistency in MacAdam ellipses (SDCM)  
CCT 4000K
-  — Colour consistency in MacAdam ellipses (SDCM)  
CCT 5000K
-  — The product does not contain mercury  
Free
-  — Class of protection against dust and moisture. The product is protected against the ingress of water and dust particles into the housing  
IP54