

TECHNICAL CARD



LED Street Light



Pursuant to the provisions of the WEEE Act, it is forbidden to put waste equipment marked with the symbol of a crossed out bin together with other waste. The user, wishing to get rid of electronic and electrical equipment, is obliged to return it to a waste equipment collection point. There are no hazardous components in the equipment that have a particularly negative impact on the environment and human health.

VIDEX®

VIDEX IP65 SLE17 30W 3300Lm 5000K 230V

INDEX: VL-SLE17-0305



WARRANTY 2 YEARS

NEUTRAL WHITE



Neutral White / Neutralny biały / Neutralni bila / Blanc neuter / Neutrálna biela / Neutraal wit / Semleges feher / Nevtralno bela / Neutralno bijela / Neutralweiß / Alb neutru / Neutralus balta / Neitrāls balta / Neutraalne valge / Нейтрално бяла / Bianco neutro.

General parameters

Light source or containing product	Light source
Light source replaceable	no
Control gear replaceable	-

Type of light source

Energy class of the light source	E
Dimmable	no
Directional (DLS) or non-directional (NDLS) light source	DLS
Connected light source (cls)	no
Color-tunable light source	no
Mains (MLS) or non-mains (NMLS) light source	MLS

High luminance light source	No
Anti-glare shield	No
Technology	LED

Electrical parameters

On-mode power (Pon)	30 W
Rated voltage, frequency	AC 180-265 V, 50/60 Hz
Rated current	140 mA
Input interface	Free wire ends
Electric shock protection class	I
Displacement factor (cos φ1)	0.95
Survival factor	0.9
Energy consumption in on-mode of the light source (kWh/1000h)	30

Photometric parameters

Luminous flux	3300 Lm
Useful luminous flux (Φuse)	3000 Lm
Correlated color temperature	5000K (neutral white)
Beam angle	90 × 130°
Color rendering index (CRI)	Ra > 80
On/Off cycles	20000
Lifetime (L70B50)	30000 h
Useful luminous flux of the light source reference	in a wide cone (120°)
Chromaticity coordinates (x)	0.35
Chromaticity coordinates (y)	0.36

INDEX: VL-SLE17-0305

R9 colour rendering index value	>0
The lumen maintenance factor	≥96%
Flicker metric (Pst LM)	≤1
Stroboscopic effect metric (SVM)	outdoor use
Colour consistency in MacAdam ellipses (SDCM)	<6 (5000K)
CRI Min	Ra 80
CRI Max	Ra 88

Additional information

Vertical adjustment range	30°
Place of installation	Pillar, Wall
Place of application	indoor, outdoor
Impact protection	IK07
Housing colour	Gray
Diffuser material	Polycarbonate (PC)
Minimum distance from the illuminated object	0.5 m
Ultraviolet radiation	no
Operating temperature range	-30° +50°C
Suitable for installation in normally flammable surfaces	yes
Mercury content	Does not contain
Ingress protection	IP65
Housing material	Aluminum alloy

Dimensions

EAN	4820246485579
------------	---------------

In the package	1 pc.
Outer box	10 pcs.
Height	409 mm
Width	106 mm
Depth	83 mm
Unit nett weight	630g

Signs marking goods

Packaging marking

Recycling of waste, CE, Utilization



VIDEX[®]

VIDEX IP65 SLE17 30W 3300Lm 5000K 230V



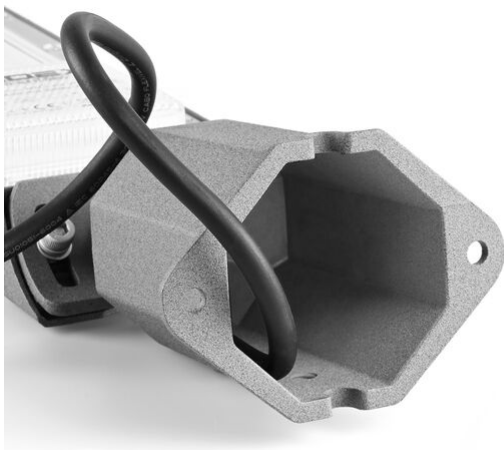
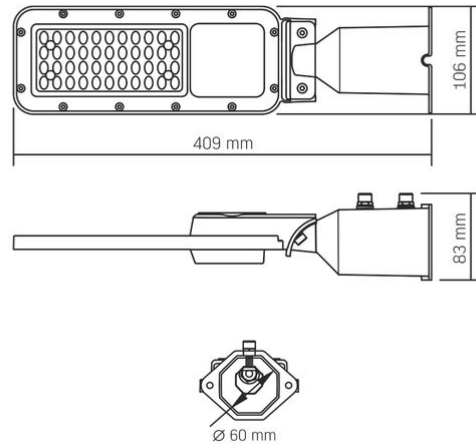
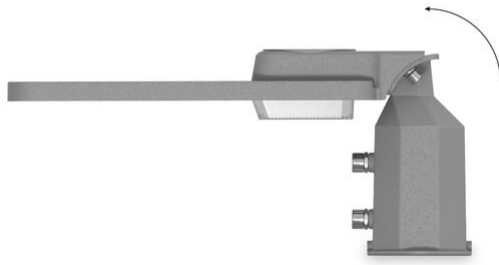

















INDEX: VL-SLE17-0305

VIDEX[®]**VIDEX IP65 SLE17 30W 3300Lm 5000K 230V****INDEX: VL-SLE17-0305**

We reserve the right to make technical changes. The data contained in this material is not legally binding.

Allegro opt Sp. z o.o., ul. Mierzeja Wiślana 11,
30-732 Krakow, Poland.

INDEX: VL-SLE17-0305

-  The product must be used indoors
-  The product must be used outdoors
-  Protection against electric shock class I. A product in which the means of protection against electric shock, in addition to the main insulation, is an additional protective circuit connected to the grounding of the power supply network
-  Minimum distance from the illuminated object
0,5 m
-  The product can be installed and used in/on normally flammable surfaces
-  Waste recycling after the end of the product's service life
-  The product meets the requirements of EU directives
-  It is forbidden to throw away waste equipment marked with the symbol of a crossed-out bin with other waste
-  — Effective light beam angle
90°-130°
-  — Ra > 80 - color rendering index
Ra ≥ 80
-  — Rated On/off cycles
ON/OFF
20 000
-  — The product withstands a medium impact (e.g., from a blunt object)
IK07
-  — Nominal lifetime (hours)
30 000 h
-  — The product does not emit ultraviolet light
Free
-  — The product is incompatible with light regulators
Not Dimmable
-  — Operating temperatures range
-30° +50°C
-  — The flickering of the light does not exceed the permissible level
No Flicker
-  — Colour consistency in MacAdam ellipses (SDCM)
CCT 5000K
-  — The product does not contain mercury
Free
-  — Class of protection against dust and moisture. The product has full protection against dust and water jets from all directions
IP65