

## TECHNICAL CARD



LED Ceiling Light



Pursuant to the provisions of the WEEE Act, it is forbidden to put waste equipment marked with the symbol of a crossed out bin together with other waste. The user, wishing to get rid of electronic and electrical equipment, is obliged to return it to a waste equipment collection point. There are no hazardous components in the equipment that have a particularly negative impact on the environment and human health.

## INDEX: VL-DL6S-12CW



Ra ≥ 80



25 000 h



Free



Not Dimmable



-20° +40°C



No Flicker



CCT 3000K



CCT 4000K



CCT 6500K



Free



IP20

## WARRANTY 2 YEARS

### General parameters

Light source or containing product	Light source
Control gear replaceable	-
Light source replaceable	no

### Type of light source

Energy class of the light source	F
Dimmable	no
Directional (DLS) or non-directional (NDLS) light source	NDLS
Connected light source (cls)	no
Color-tunable light source	yes
Mains (MLS) or non-mains (NMLS) light source	MLS
High luminance light source	No
Anti-glare shield	No
Technology	LED

### Electrical parameters

On-mode power (Pon)	12 W
Rated voltage, frequency	AC 220-240 V, 50/60 Hz
Rated current	75 mA
Input interface	Terminal block
Electric shock protection class	II
Displacement factor (cos φ1)	0.7
Survival factor	1
Energy consumption in on-mode of the light source (kWh/1000h)	12

### Photometric parameters

Useful luminous flux (Φuse)	1170 Lm
Correlated color temperature	6500K (cold white), 4000K (neutral white), 3000K (warm white)
Beam angle	140°
Color rendering index (CRI)	Ra > 80
On/Off cycles	15000
Lifetime (L70B50)	25000 h
Useful luminous flux of the light source reference	in a sphere (360°)
R9 colour rendering index value	>0
The lumen maintenance factor	≥94.8%
Flicker metric (Pst LM)	≤1
Stroboscopic effect metric (SVM)	-

### INDEX: VL-DL6S-12CW

**Colour consistency in MacAdam ellipses (SDCM)** <6 (3000K), <6 (4000K), <6 (6500K)

**CRI Min** Ra 80

**CRI Max** Ra 88

### Additional information

**Place of installation** Ceiling

**Place of application** indoor

**Housing colour** White

**Diffuser material** Polycarbonate (PC)

**Ultraviolet radiation** no

**Operating temperature range** -20° +40°C

**Suitable for installation in normally flammable surfaces** yes

**Mercury content** Does not contain

**Ingress protection** IP20

**Housing material** PC

### Dimensions

**EAN** 4820246487931

**In the package** 1 pc.

**Outer box** 40 pcs.

**Height** 167 mm

**Width** 167 mm

**Depth** 17 mm

**Unit nett weight** 284g

### Signs marking goods

#### Packaging marking

Recycling of waste, CE, Utilization



**VIDEX<sup>®</sup>**

VIDEX DL6S 12W 3000K-4000K-6500K 230V White

**INDEX: VL-DL6S-12CW**

# VIDEX®

VIDEX DL6S 12W 3000K-4000K-65000K 230V White



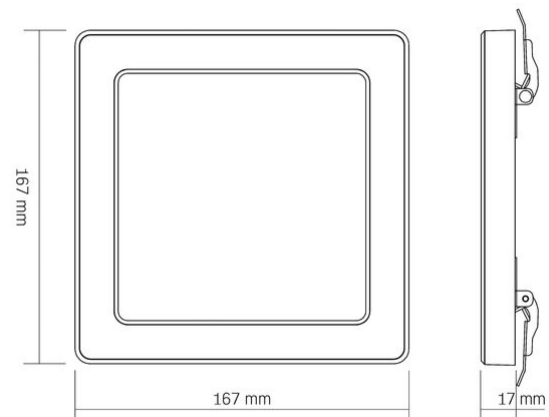
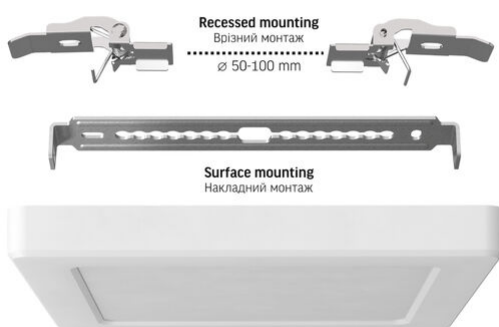









INDEX: VL-DL6S-12CW



We reserve the right to make technical changes. The data contained in this material is not legally binding.

Allegro opt Sp. z o.o., ul. Mierzeja Wiślana 11,  
30-732 Krakow, Poland.

## INDEX: VL-DL6S-12CW

-  The product must be used indoors
-  Class of protection against electric shock II - provided not only by basic insulation but also by double or reinforced insulation
-  The product can be installed and used in/on normally flammable surfaces
-  Waste recycling after the end of the product's service life
-  The product meets the requirements of EU directives
-  It is forbidden to throw away waste equipment marked with the symbol of a crossed-out bin with other waste
-  — Ra > 80 - color rendering index
-  — Nominal lifetime (hours)  
25 000 h
-  — The product does not emit ultraviolet light  
Free
-  — The product is incompatible with light regulators  
Not Dimmable
-  — Operating temperatures range  
-20° ~ +40°C
-  — The flickering of the light does not exceed the permissible level  
No Flicker
-  — Colour consistency in MacAdam ellipses (SDCM)  
CCT 3000K
-  — Colour consistency in MacAdam ellipses (SDCM)  
CCT 4000K
-  — Colour consistency in MacAdam ellipses (SDCM)  
CCT 6500K
-  — The product does not contain mercury  
Free
-  — Class of protection against dust and moisture.  
Protection against solid objects larger than 12 mm; no protection against moisture  
IP20