

TECHNICAL CARD

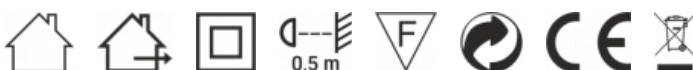

LED Ceiling Light with decorative backlight



Pursuant to the provisions of the WEEE Act, it is forbidden to put waste equipment marked with the symbol of a crossed out bin together with other waste. The user, wishing to get rid of electronic and electrical equipment, is obliged to return it to a waste equipment collection point. There are no hazardous components in the equipment that have a particularly negative impact on the environment and human health.

INDEX: VL-DL5R-22CW



WARRANTY 2 YEARS

General parameters

Light source or containing product	Light source
Light source replaceable	no

Type of light source

Energy class of the light source	F
Dimmable	no
Directional (DLS) or non-directional (NDLS) light source	NDLS
Connected light source (cls)	no
Color-tunable light source	yes
Mains (MLS) or non-mains (NMLS) light source	MLS
High luminance light source	No
Anti-glare shield	No
Technology	LED

Electrical parameters

On-mode power (Pon)	22 W
Rated voltage, frequency	AC 220-240 V, 50/60 Hz
Rated current	136 mA
Input interface	Terminal block
Electric shock protection class	II
Displacement factor (cos φ1)	0.7
Survival factor	1
Energy consumption in on-mode of the light source (kWh/1000h)	22

Photometric parameters

Useful luminous flux (Φuse)	2400 Lm
Correlated color temperature	5000K (neutral white), 4000K (neutral white), 3000K (warm white)
Beam angle	140°
Color rendering index (CRI)	Ra > 80
On/Off cycles	20000
Lifetime (L70B50)	30000 h
Useful luminous flux of the light source reference	in a sphere (360°)
R9 colour rendering index value	>0
The lumen maintenance factor	≥96%
Flicker metric (Pst LM)	≤1
Stroboscopic effect metric (SVM)	-

INDEX: VL-DL5R-22CW

Colour consistency in MacAdam ellipses (SDCM) <6 (3000K), <6 (4000K), <6 (5000K)

CRI Min Ra 80

CRI Max Ra 88

Additional information

Place of installation	Ceiling
Place of application	indoor, outdoor
Housing colour	White
Diffuser material	Polypropylene (PP)
Minimum distance from the illuminated object	0.5 m
Ultraviolet radiation	no
Operating temperature range	-20° +40°C
Suitable for installation in normally flammable surfaces	yes
Mercury content	Does not contain
Ingress protection	IP54
Housing material	ABS

Dimensions

EAN	4820246487351
In the package	1 pc.
Height	293 mm
Outer box	20 pcs.
Width	293 mm
Depth	26 mm
Unit nett weight	580g

Signs marking goods

Packaging marking

Recycling of waste, CE, Utilization



VIDEX[®]

VIDEX DL5R 22W 3000K-4000K-5000K 230V White

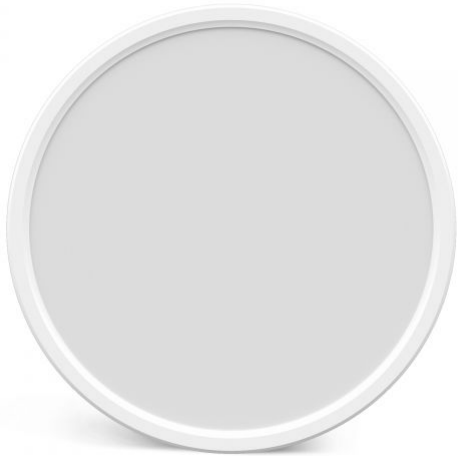
INDEX: VL-DL5R-22CW

VIDEX®



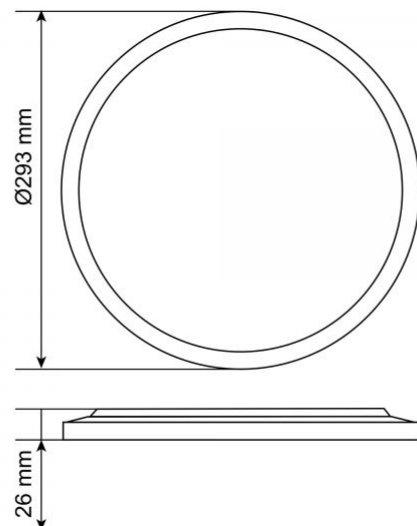

















VIDEX DL5R 22W 3000K-4000K-5000K 230V White

INDEX: VL-DL5R-22CW

We reserve the right to make technical changes. The data contained in this material is not legally binding.

Allegro opt Sp. z o.o., ul. Mierzeja Wiślana 11,
30-732 Krakow, Poland.

INDEX: VL-DL5R-22CW

-  The product must be used indoors
-  The product must be used outdoors
-  Class of protection against electric shock II - provided not only by basic insulation but also by double or reinforced insulation
-  Minimum distance from the illuminated object
0,5 m
-  The product can be installed and used in/on normally flammable surfaces
-  Waste recycling after the end of the product's service life
-  The product meets the requirements of EU directives
-  It is forbidden to throw away waste equipment marked with the symbol of a crossed-out bin with other waste
-  — Ra > 80 - color rendering index
-  — Rated On/off cycles
20 000
-  — Nominal lifetime (hours)
30 000 h
-  — The product does not emit ultraviolet light
Free
-  — The product is incompatible with light regulators
Not Dimmable
-  — Operating temperatures range
-20° +40°C
-  — The flickering of the light does not exceed the permissible level
No Flicker
-  — Colour consistency in MacAdam ellipses (SDCM)
CCT 3000K
-  — Colour consistency in MacAdam ellipses (SDCM)
CCT 4000K
-  — Colour consistency in MacAdam ellipses (SDCM)
CCT 5000K
-  — The product does not contain mercury
Free
-  — Class of protection against dust and moisture. The product is protected against the ingress of water and dust particles into the housing
IP54