

VIDEX®

VIDEX 12W 3000K-4000K-6500K 1200Lm Weiß

INDEX: VL-WL03-12CW

TECHNISCHE KARTE



LED Wandleuchte IP65



Gemäß den Bestimmungen des WEEE-Gesetzes ist es verboten, Altgeräte, die mit dem Symbol einer durchgekreuzten Mülltonne gekennzeichnet sind, zusammen mit anderen Abfällen zu entsorgen. Der Benutzer, der elektronische und elektrische Geräte abgeben möchte, ist verpflichtet, diese an einer Sammelstelle für Altgeräte abzugeben. Das Gerät enthält keine gefährlichen Bestandteile, die sich besonders negativ auf die Umwelt und die menschliche Gesundheit auswirken.

VIDEX®

VIDEX 12W 3000K-4000K-6500K 1200Lm Weiß

INDEX: VL-WL03-12CW



GARANTIE 2 JAHRE



Allgemeine Parameter

Lichtquelle oder Produkt mit integrierter Lichtquelle	Lichtquelle
Austauschbare Lichtquelle	nein

Art der Lichtquelle

Energieeffizienzklasse	F
Dimmbar	nein
Gerichtete (DLS) oder nicht gerichtete (NDLS) Lichtquelle	NDLS
Vernetzte Lichtquelle (CLS)	nein
Farblich abstimmbare Lichtquelle	ja
Lichtquelle mit hoher Leuchtdichte	nein
Netzbetriebene (MLS) oder nicht netzbetriebene (NMLS) Lichtquelle	MLS
Blendfreier Schutzschirm	nein
Technologie	LED

Elektrische Parameter

Leistung	12 W
Hochspannung	AC 220-240 V, 50/60 Hz
Maximale Stromstärke	75 mA
Verbindungsschnittstelle	Klemmenblock
Schutzklasse gegen elektrischen Schlag	II
Verschiebungsfaktor (cos φ1)	0.7
Überlebensfaktor	1
Energieverbrauch im Betriebsmodus der Lichtquelle (kWh/1000h)	12

Photometrische Parameter

Farbtemperatur des Lichts	6500K (weißes Licht), 4000K (neutralweiß), 3000K (warmes Licht)
Streuwinkel	120°
Lichtqualität	Ra > 80
Ein/Aus-Zyklen	15000
Arbeitsressource (L70B50)	25000 Std
Der Wert des nutzbaren Lichtstroms	in der Kugel (360°)
Farbwiedergabeindexwert R9	>0
The lumen maintenance factor	≥94.8%
Flimmerkennzahl (Pst LM)	≤1
Stroboskopeffektkennzahl (SVM)	≤0.4
Farbkonsistenz in MacAdam-Ellipsen (SDCM)	<6 (3000K), <6 (4000K), <6 (6500K)
CRI MIN	Ra 80
CRI MAX	Ra 88

INDEX: VL-WL03-12CW
Zusätzliche Information

Ort der Installation	Ebene Fläche, Wand
Einsatzumgebung	innerhalb, draußen
Aufprallschutz	IK06
Farbe des Gehäuses	Weiß
Diffusor material	Polycarbonat (PC)
Mindestabstand zum beleuchteten Objekt	0.5 m
UV-Strahlung	nein
Bewegungssensor	nein
Umgebungstemperaturbereich	-20° +50°C
Geeignet für die Installation auf normal entflammaren Oberflächen	ja
Quecksilbergehalt	nein
Schutzklasse, IP	IP65
Gehäusematerial	Kunststoff

Maße

Strichcode	4820246487979
Im Paket	1 Stk.
Höhe	180 mm
Menge in der Kiste	20 Stk.
Breite	180 mm
Tiefe	47 mm
Einheit Nettogewicht	250g

Warenkennzeichnungsschilder
Verpackungskennzeichnung

 CE,
Entsorgungsmethode



VIDEX®

VIDEX 12W 3000K-4000K-6500K 1200Lm Weiß

INDEX: VL-WL03-12CW

VIDEX®

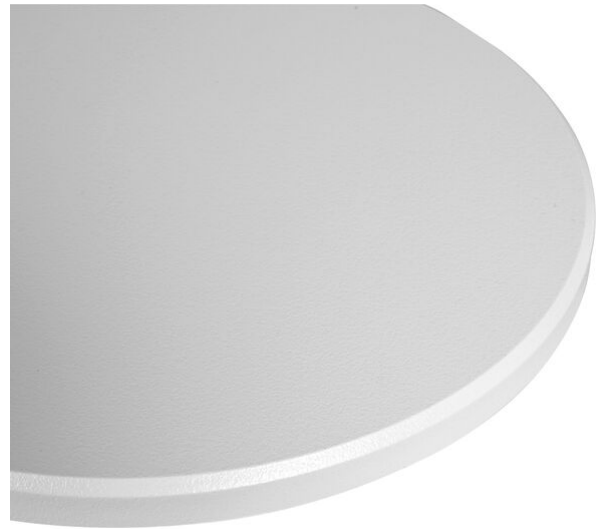
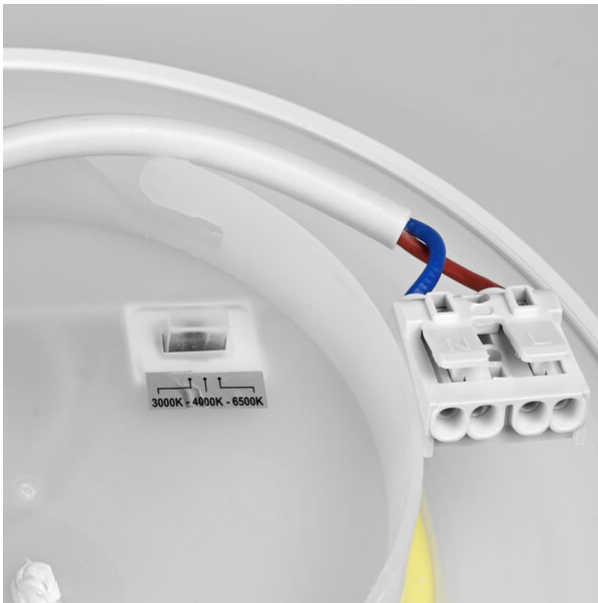
VIDEX 12W 3000K-4000K-6500K 1200Lm Weiß

INDEX: VL-WL03-12CW

VIDEX[®]

VIDEX 12W 3000K-4000K-6500K 1200Lm Weiß

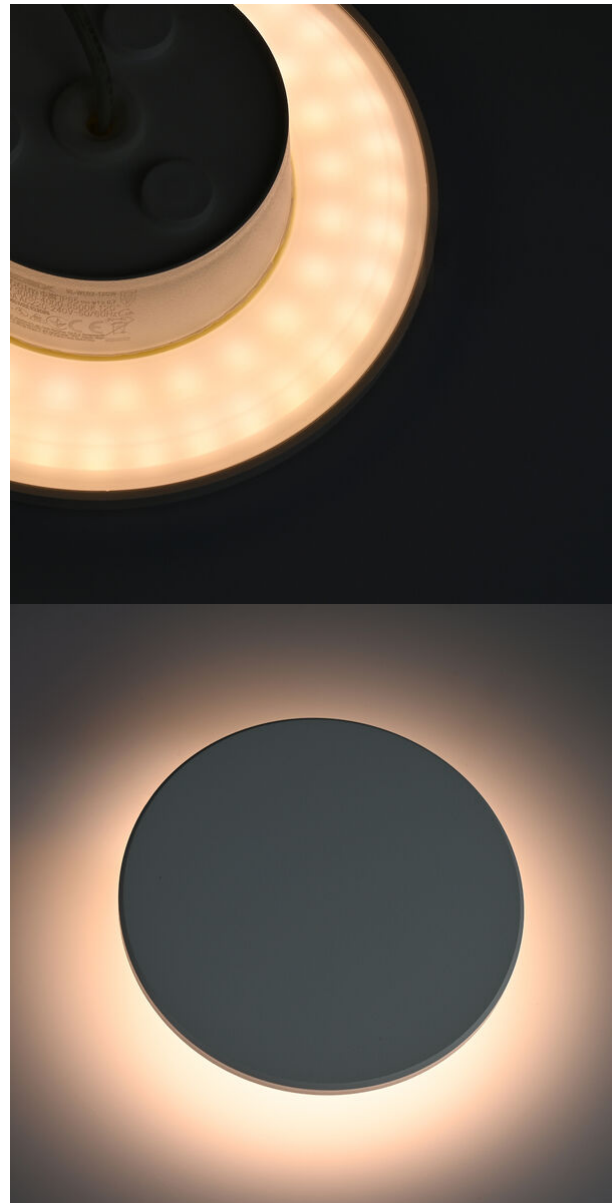
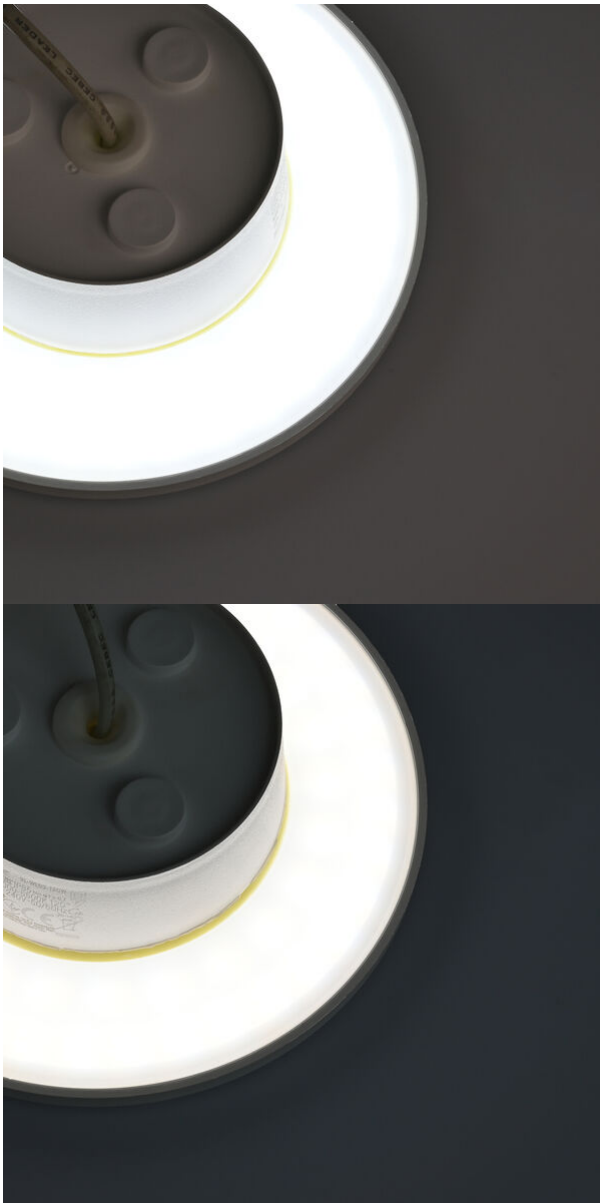
INDEX: VL-WL03-12CW

VIDEX®

VIDEX 12W 3000K-4000K-6500K 1200Lm Weiß

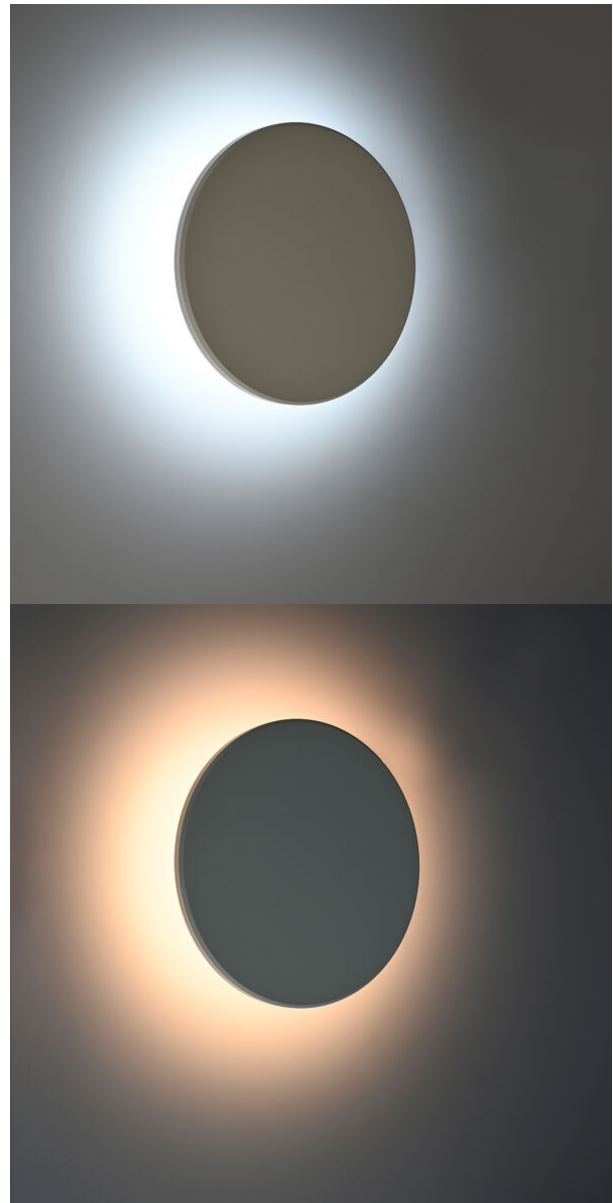
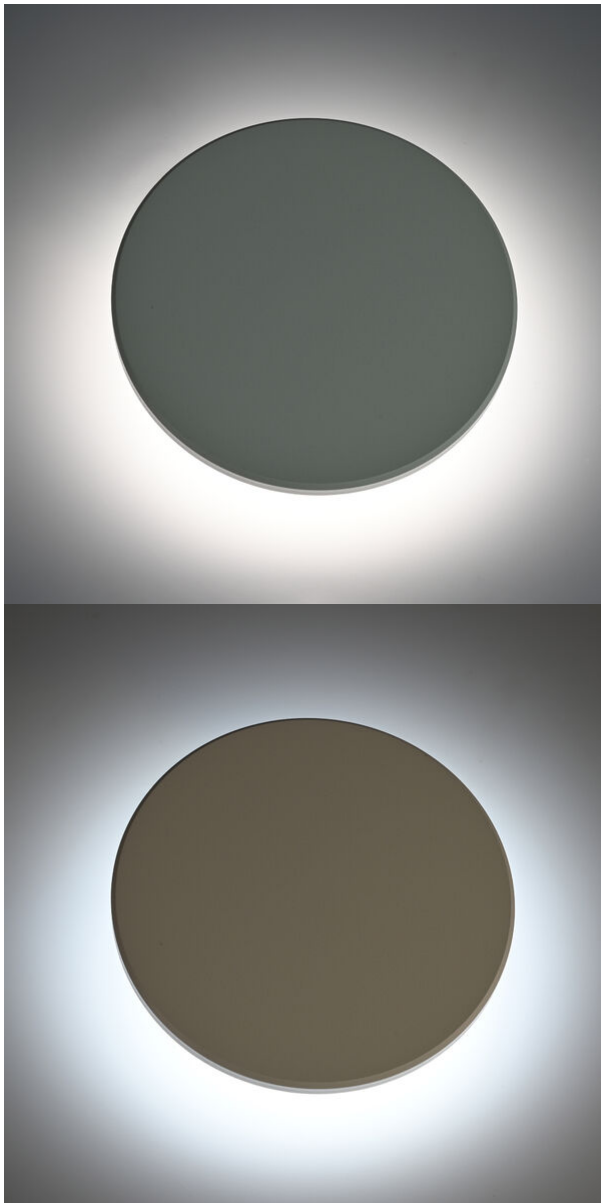
INDEX: VL-WL03-12CW

VIDEX®

VIDEX 12W 3000K-4000K-6500K 1200Lm Weiß

INDEX: VL-WL03-12CW

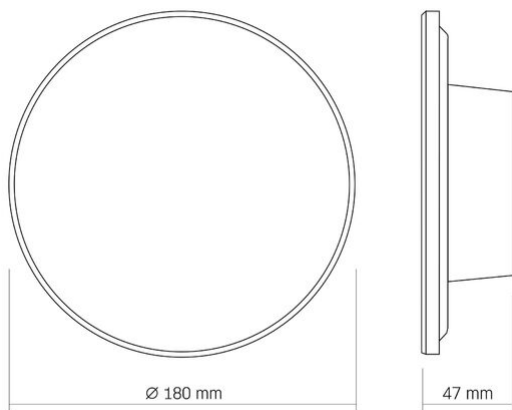

Technische Änderungen vorbehalten. Die darin enthaltenen Daten Material ist nicht rechtlich bindend.

Allegro opt Sp. z o.o., ul. Mierzeja Wiślana 11, 30-732 Krakow, Polen.

-  Das Produkt muss in Innenräumen verwendet werden
-  Das Produkt muss im Freien verwendet werden
-  Schutzklasse gegen elektrischen Schlag II - wird nicht nur durch Basisisolierung, sondern auch durch doppelte oder verstärkte Isolierung gewährleistet
-  Mindestabstand zum beleuchteten Objekt
-  Das Produkt kann in/auf normal entflammaren Oberflächen installiert und verwendet werden
-  Das Produkt entspricht den Anforderungen der EU-Richtlinien
-  Es ist verboten, Altgeräte, die mit dem Symbol einer durchgestrichenen Mülltonne gekennzeichnet sind, mit dem Restmüll zu entsorgen
-  — Bewerteter Abstrahlwinkel
-  — Ra > 80 - Farbwiedergabeindex
-  — Nominelle Lebensdauer (Stunden)
-  — Das Produkt emittiert kein ultraviolettes Licht
-  — Das Produkt ist nicht kompatibel mit Lichtreglern
-  — Betriebstemperaturbereich
-  — Das Flimmern des Lichts überschreitet nicht den zulässigen Wert
-  — Das Produkt hat minimales Flimmern, das keine Unannehmlichkeiten oder Gefahr verursachen sollte
-  — Farbkonsistenz in MacAdam-Ellipsen (SDCM)
-  — Farbkonsistenz in MacAdam-Ellipsen (SDCM)
-  — Farbkonsistenz in MacAdam-Ellipsen (SDCM)
-  — Das Produkt enthält kein Quecksilber
-  — Schutzklasse gegen Staub und Feuchtigkeit. Das Produkt hat vollständigen Schutz gegen Staub und Wasserstrahlen aus allen Richtungen