

TECHNICAL CARD



LED Track Light



Pursuant to the provisions of the WEEE Act, it is forbidden to put waste equipment marked with the symbol of a crossed out bin together with other waste. The user, wishing to get rid of electronic and electrical equipment, is obliged to return it to a waste equipment collection point. There are no hazardous components in the equipment that have a particularly negative impact on the environment and human health.

VIDEX®



36°



Ra ≥ 90



ON/OFF

20 000



30 000 h



Free



Not Dimmable



-20° +40°C



No Flicker



No Flicker



<6x ellipse MacAdam

CCT 4000K



Free



IP20

WARRANTY 3 YEARS

NEUTRAL WHITE



4000K

Neutral White / Neutralny biały / Neutralni bila / Blanc neuter / Neutrálna biela / Neutraal wit / Semleges feher / Nevtralno bela / Neutralno bijela / Neutralweiß / Alb neutru / Neutralus balta / Neitrāls balta / Neutraalne valge / Нейтрално бяла / Bianco neutro.

General parameters

Light source or containing product Light source

Light source replaceable by the producer

Type of light source

Energy class of the light source F

Dimmable no

Directional (DLS) or non-directional (NDLS) light source DLS

Color-tunable light source no

Mains (MLS) or non-mains (NMLS) light source MLS

Technology LED

VIDEX-TOR-20W-WHITE

INDEX: VLE-TR04-204W

Electrical parameters

On-mode power (Pon) 20 W

Rated voltage, frequency AC 220-240 V, 50/60 Hz

Rated current 170 mA

Input interface 2 Wires Busbar

Electric shock protection class II

Displacement factor (cos φ1) 0.7

Energy consumption in on-mode of the light source (kWh/1000h) 20

Photometric parameters

Useful luminous flux (Φuse) 1600 Lm

Correlated color temperature 4000K (neutral white)

Beam angle 36°

Color rendering index (CRI) Ra > 90

On/Off cycles 20000

Lifetime (L70B50) 30000 h

Useful luminous flux of the light source reference in a narrow cone (90°)

Chromaticity coordinates (x) 0.38

Chromaticity coordinates (y) 0.38

R9 colour rendering index value >0

Flicker metric (Pst LM) ≤1

Stroboscopic effect metric (SVM) ≤0.4

Colour consistency in MacAdam ellipses (SDCM) <6 (4000K)

CRI Min Ra 90

VIDEX®

VIDEX-TOR-20W-WHITE

INDEX: VLE-TR04-204W

CRI Max Ra 95

Additional information

Place of installation	Busbar track
Place of application	indoor
Housing colour	White
Diffuser material	PMMA
Minimum distance from the illuminated object	0.5 m
Ultraviolet radiation	no
Operating temperature range	-20° +40°C
Suitable for installation in normally flammable surfaces	yes
Mercury content	Does not contain
Ingress protection	IP20
Housing material	Aluminum alloy

Dimensions

EAN	5904405541463
In the package	1 pc.
Height	156 mm
Outer box	20 pcs.
Width	66 mm
Depth	66 mm

Signs marking goods

Packaging marking	Recycling of waste, CE, Utilization
--------------------------	-------------------------------------



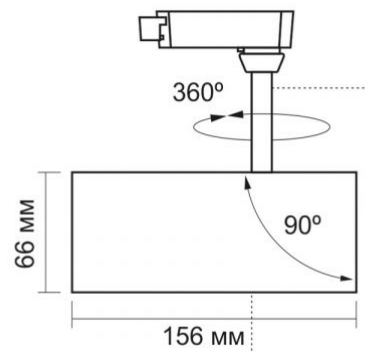



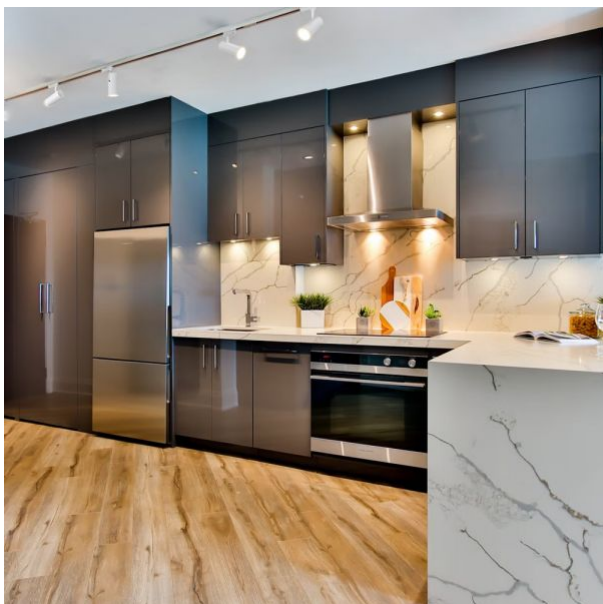













VIDEX[®]**VIDEX-TOR-20W-WHITE****INDEX: VLE-TR04-204W**

INDEX: VLE-TR04-204W



We reserve the right to make technical changes. The data contained in this material is not legally binding.

Allegro opt Sp. z o.o., ul. Mierzeja Wiślana 11,
30-732 Krakow, Poland.

-  The product must be used indoors
-  Class of protection against electric shock II - provided not only by basic insulation but also by double or reinforced insulation
-  Minimum distance from the illuminated object
0,5 m
-  The product can be installed and used in/on normally flammable surfaces
-  Waste recycling after the end of the product's service life
-  The product meets the requirements of EU directives
-  It is forbidden to throw away waste equipment marked with the symbol of a crossed-out bin with other waste
-  — Rated beam angle
36°
-  — Ra > 90 - color rendering index
Ra > 90
-  — Rated On/off cycles
20 000
-  — Nominal lifetime (hours)
30 000 h
-  — The product does not emit ultraviolet light
Free
-  — The product is incompatible with light regulators
Not Dimmable
-  — Operating temperatures range
-20°-40°C
-  — The flickering of the light does not exceed the permissible level
No Flicker
-  — The product has minimal flickering, which should not cause discomfort or danger
No Flicker
-  — Colour consistency in MacAdam ellipses (SDCM)
CCT 4000K
-  — The product does not contain mercury
Free
-  — Class of protection against dust and moisture. Protection against solid objects larger than 12 mm; no protection against moisture
IP20