

VIDEX®

VIDEX VL-TRMS-LA76B Black

INDEX: VL-TRMS-LA76B

TECHNICAL CARD



LED Light for Magnetic slim track light system



Pursuant to the provisions of the WEEE Act, it is forbidden to put waste equipment marked with the symbol of a crossed out bin together with other waste. The user, wishing to get rid of electronic and electrical equipment, is obliged to return it to a waste equipment collection point. There are no hazardous components in the equipment that have a particularly negative impact on the environment and human health.

VIDEX®

VIDEX VL-TRMS-LA76B Black

INDEX: VL-TRMS-LA76B

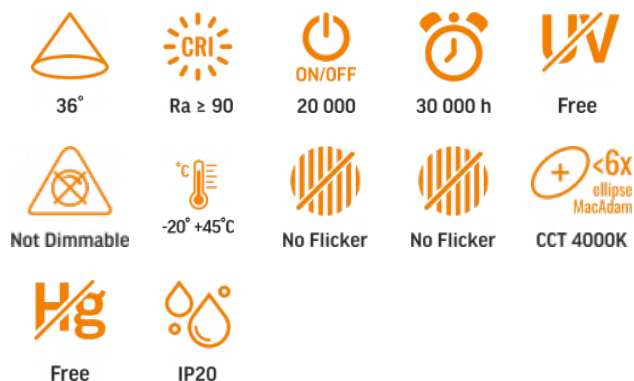

WARRANTY 3 YEARS



Neutral White / Neutralny biały / Neutralni bila / Blanc neuter / Neutrálna biela / Neutraal wit / Semleges feher / Nevtralno bela / Neutralno bijela / Neutralweiß / Alb neutru / Neutralus balta / Neitrāls balta / Neutraalne valge / Нейтрално бяла / Bianco neutro.

General parameters

Light source or containing product	Light source
------------------------------------	--------------

Light source replaceable	no
--------------------------	----

Type of light source

Energy class of the light source	F
----------------------------------	---

Dimmable	no
----------	----

Directional (DLS) or non-directional (NDLS) light source	DLS
--	-----

Connected light source (cls)	no
------------------------------	----

Color-tunable light source	no
----------------------------	----

Mains (MLS) or non-mains (NMLS) light source	NMLS
--	------

High luminance light source	No
-----------------------------	----

Anti-glare shield	No
Technology	LED

Electrical parameters

On-mode power (Pon)	8.5 W
---------------------	-------

Rated voltage, frequency	DC 48 V
--------------------------	---------

Rated current	167 mA
---------------	--------

Input interface	2 Wires Busbar
-----------------	-------------------

Electric shock protection class	III
---------------------------------	-----

Displacement factor (cos φ1)	0.9
------------------------------	-----

Survival factor	1
-----------------	---

Energy consumption in on-mode of the light source (kWh/1000h)	8.5
---	-----

Photometric parameters

Useful luminous flux (Φuse)	720 Lm
-----------------------------	--------

Correlated color temperature	4000K (neutral white)
------------------------------	--------------------------

Beam angle	36°
------------	-----

Color rendering index (CRI)	Ra > 90
-----------------------------	---------

On/Off cycles	20000
---------------	-------

Lifetime (L70B50)	30000 h
-------------------	---------

Useful luminous flux of the light source reference	in a narrow cone (90°)
--	------------------------

Chromaticity coordinates (x)	0.38
------------------------------	------

Chromaticity coordinates (y)	0.38
------------------------------	------

R9 colour rendering index value	>0
---------------------------------	----

The lumen maintenance factor	≥96%
------------------------------	------

VIDEX®

VIDEX VL-TRMS-LA76B Black

INDEX: VL-TRMS-LA76B

Flicker metric (Pst LM)	≤1
Stroboscopic effect metric (SVM)	≤0.4
Colour consistency in MacAdam ellipses (SDCM)	<6 (4000K)
CRI Min	Ra 90
CRI Max	Ra 95

Unit nett weight	215g
------------------	------

Signs marking goods

Packaging marking

Recycling of
waste, CE,
Utilization

Additional information

Place of installation	Busbar for magnetic slim track
Place of application	indoor
Housing colour	Black
Diffuser material	Polycarbonate (PC)
Minimum distance from the illuminated object	0.5 m
Ultraviolet radiation	no
Operating temperature range	-20° +45°C
Mercury content	Does not contain
Ingress protection	IP20
Housing material	Aluminum alloy, Acrylic

Dimensions

EAN	4820246485715
In the package	1 pc.
Height	111 mm
Outer box	32 pcs.
Width	60 mm
Depth	57 mm



VIDEX®

VIDEX VL-TRMS-LA76B Black

INDEX: VL-TRMS-LA76B

VIDEX®

VIDEX VL-TRMS-LA76B Black



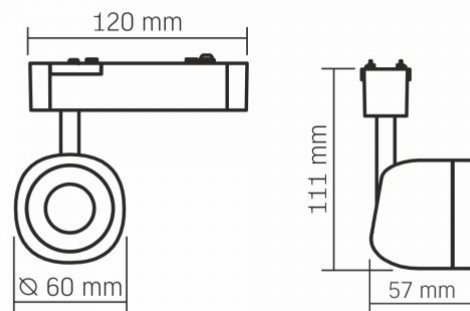















INDEX: VL-TRMS-LA76B



We reserve the right to make technical changes. The data contained in this material is not legally binding.

Allegro opt Sp. z o.o., ul. Mierzeja Wiślana 11,
30-732 Krakow, Poland.

INDEX: VL-TRMS-LA76B

-  The product must be used indoors
-  Class III protection against electric shock - ensured by supplying a specific product with a safe very low voltage (SELV) without the risk of creating a voltage above safe levels
-  Minimum distance from the illuminated object
0,5 m
-  Waste recycling after the end of the product's service life
-  The product meets the requirements of EU directives
-  It is forbidden to throw away waste equipment marked with the symbol of a crossed-out bin with other waste
-  — Rated beam angle
36°
-  — Ra > 90 - color rendering index
Ra > 90
-  — Rated On/off cycles
ON/OFF
20 000
-  — Nominal lifetime (hours)
30 000 h
-  — The product does not emit ultraviolet light
Free
-  — The product is incompatible with light regulators
Not Dimmable
-  — Operating temperatures range
-20° +45°C
-  — The flickering of the light does not exceed the permissible level
No Flicker
-  — The product has minimal flickering, which should not cause discomfort or danger
No Flicker
-  — Colour consistency in MacAdam ellipses (SDCM)
+ $\leq 6x$ MacAdam
CCT 4000K
-  — The product does not contain mercury
Free
-  — Class of protection against dust and moisture. Protection against solid objects larger than 12 mm; no protection against moisture
IP20