

TECHNISCHE KARTE



LED-Deckenleuchte Bulkhead



Gemäß den Bestimmungen des WEEE-Gesetzes ist es verboten, Altgeräte, die mit dem Symbol einer durchgekreuzten Mülltonne gekennzeichnet sind, zusammen mit anderen Abfällen zu entsorgen. Der Benutzer, der elektronische und elektrische Geräte abgeben möchte, ist verpflichtet, diese an einer Sammelstelle für Altgeräte abzugeben. Das Gerät enthält keine gefährlichen Bestandteile, die sich besonders negativ auf die Umwelt und die menschliche Gesundheit auswirken.

INDEX: VLE-BHFO-115



GARANTIE 2 JAHRE



Neutral White / Neutralny biały / Neutralni bila / Blanc neuter / Neutrálna biela / Neutraal wit / Semleges feher / Nevtralno bela / Neutralno bijela / Neutralweiß / Alb neutru / Neutralus balta / Neitrāls balta / Neutraalne valge / Нейтрално бяла / Bianco neutro.

Allgemeine Parameter

Lichtquelle oder Produkt mit integrierter Lichtquelle	Produkt mit integrierter Lichtquelle
Austauschbare Lichtquelle	vom Hersteller
Art der Lichtquelle	
Energieeffizienzklasse der enthaltenen Lichtquelle	F
Dimmbar	nein
Gerichtete (DLS) oder nicht gerichtete (NDLS) Lichtquelle	NDLS
Vernetzte Lichtquelle (CLS)	nein
Farblich abstimmbare Lichtquelle	nein

Netzbetriebene (MLS) oder nicht netzbetriebene (NMLS) Lichtquelle	MLS
Lichtquelle mit hoher Leuchtdichte	nein
Blendfreier Schutzschirm	nein
Technologie	LED

Elektrische Parameter

Leistung	11 W
Hochspannung	AC 220-240 V, 50/60 Hz
Maximale Stromstärke	95 mA
Verbindungsschnittstelle	Klemmenblock
Schutzklasse gegen elektrischen Schlag	II
Verschiebungsfaktor (cos φ1)	0.7
Überlebensfaktor	1
Energieverbrauch im Betriebsmodus der Lichtquelle (kWh/1000h)	11

Photometrische Parameter

Nutzbarer Lichtstrom der enthaltenen Lichtquelle (Φuse)	1150 Lm
Farbtemperatur des Lichts	5000K (neutralweiß)
Streuwinkel	120°
Lichtqualität	Ra > 80
Ein/Aus-Zyklen	20000
Arbeitsressource (L70B50)	25000 Std
Der Wert des nutzbaren Lichtstroms	in der Kugel (360°)
Chromatizitätskoordinaten (x)	0.35

INDEX: VLE-BHFO-115

Chromatizitätskoordinaten (y)	0.36
Farbwiedergabeindexwert R9	>0
The lumen maintenance factor	≥95.8%
Flimmerkennzahl (Pst LM)	≤1
Stroboskopeffektkennzahl (SVM)	≤0.4
Farbkonsistenz in MacAdam-Ellipsen (SDCM)	<6 (5000K)
CRI MIN	Ra 80
CRI MAX	Ra 89

Zusätzliche Information

Ort der Installation	Decke, Ebene Fläche, Wand
Einsatzumgebung	innerhalb, draußen
Aufprallschutz	IK07
Farbe des Gehäuses	Weiß
Diffusor material	Polycarbonat (PC)
Mindestabstand zum beleuchteten Objekt	0.5 m
UV-Strahlung	nein
Umgebungstemperaturbereich	-20° +40°C
Geeignet für die Installation auf normal entflammaren Oberflächen	ja
Quecksilbergehalt	nein
Schutzklasse, IP	IP65
Gehäusematerial	Kunststoff

Maße

Strichcode	5904405540947
------------	---------------

Im Paket	1 Stk.
Höhe	190 mm
Menge in der Kiste	24 Stk.
Breite	113 mm
Tiefe	40 mm
Einheit Nettogewicht	220g

Warenkennzeichnungsschilder

Verpackungskennzeichnung	Recycling von Abfällen, CE, Entsorgungsmethode
--------------------------	--



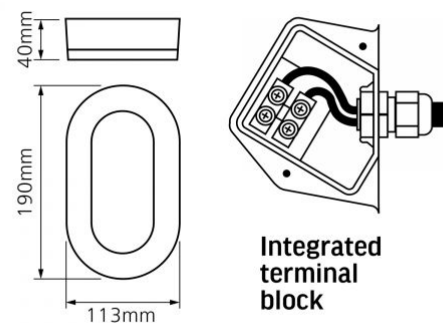



















VIDEX®**VIDEX-BULKHEAD-LED-GALA-11W-NW****INDEX: VLE-BHFO-115**

Technische Änderungen vorbehalten. Die darin enthaltenen Daten Material ist nicht rechtlich bindend.

Allegro opt Sp. z o.o., ul. Mierzeja Wiślana 11,
30-732 Krakow, Polen.

INDEX: VLE-BHFO-115

-  Das Produkt muss in Innenräumen verwendet werden
-  Das Produkt muss im Freien verwendet werden
-  Schutzklasse gegen elektrischen Schlag II - wird nicht nur durch Basisisolierung, sondern auch durch doppelte oder verstärkte Isolierung gewährleistet
-  Mindestabstand zum beleuchteten Objekt
0,5 m
-  Das Produkt kann in/auf normal entflammaren Oberflächen installiert und verwendet werden
-  Abfallverwertung nach Ablauf der Lebensdauer des Produkts
-  Das Produkt entspricht den Anforderungen der EU-Richtlinien
-  Es ist verboten, Altgeräte, die mit dem Symbol einer durchgestrichenen Mülltonne gekennzeichnet sind, mit dem Restmüll zu entsorgen
-  — Bewerteter Abstrahlwinkel
120°
-  — Ra > 80 - Farbwiedergabeindex
Ra ≥ 80
-  — Nenn-Ein/Aus-Zyklen
ON/OFF
20 000
-  — Das Produkt hält einen mittleren Schlag aus (z. B. von einem stumpfen Gegenstand)
IK07
-  — Nominelle Lebensdauer (Stunden)
25 000 h
-  — Das Produkt emittiert kein ultraviolettes Licht
Free
-  — Das Produkt ist nicht kompatibel mit Lichtreglern
Not Dimmable
-  — Betriebstemperaturbereich
-20° +40°C
-  — Das Flimmern des Lichts überschreitet nicht den zulässigen Wert
No Flicker
-  — Das Produkt hat minimales Flimmern, das keine Unannehmlichkeiten oder Gefahr verursachen sollte
No Flicker
-  — Farbkonsistenz in MacAdam-Ellipsen (SDCM)
CCT 5000K
-  — Das Produkt enthält kein Quecksilber
Free
-  — Schutzklasse gegen Staub und Feuchtigkeit. Das Produkt hat vollständigen Schutz gegen Staub und Wasserstrahlen aus allen Richtungen
IP65